

Directional spool valves type SKP and SKH

The directional spool valve banks type SKP or SKH serve to control the direction of movement of hydraulic consumers e.g. motors or cylinders. The individual directional spool valve may be either connected in parallel (type SKP) or in series (type SKH) depending on flow pattern. Mixed combinations are also possible.

The valve bank consists of a starting spool valve block with or without pressure limiting valve, the add-on valve sections and the end plate. There are connection blocks available enabling direct mounting onto hydraulic power packs with fluid immersed motor (type R, RZ, Z), hydraulic power packs (type HC, MP, HK) or for pipe connection.

A wide range of actuations (manual, solenoid, hydraulic and pneumatic) enable these directional spool valves to be used in a wide range of applications.



Nomenclature:	Directional spool valve
Design:	Valve bank connected in parallel (SKP) or in series (SKH) combination with hydraulic power packs
Actuation:	Solenoid Manual <ul style="list-style-type: none"> • With autom. spring return • With detent Pressure (only or combined with manual actuation) <ul style="list-style-type: none"> • Hydraulic • Pneumatic
P_{max}:	200 ... 400 bar
Q_{max}:	12 ... 100 lpm

Basic types and general parameters

Basic type and size		Flow Q _{max} (lpm)	Oper. pressure p _{max} (bar) for actuation version				Tapped ports (BSPP)
Connected in parallel	in series		Manual	Solenoid	Pressure	Manual / pressure	
SKP - 0	SKH - 0	12	400	200	400	400	G 1/4 ¹⁾ / G 3/8
SKP - 1	SKH - 1	20	400	200	400	400	G 3/8
SKP - 2	SKH - 2	30	400	315	400	400	G 3/8
SKP - 3	SKH - 3	50	400	315	400	400	G 1/2
SKP - 4	SKH - 4	100	400	200	400	400	G 3/4

Permissible turn pressure 12...100 bar depending on valve type and actuation

¹⁾ Port P at the under side with SKH = G 3/8 (BSPP)

Valve bank coding

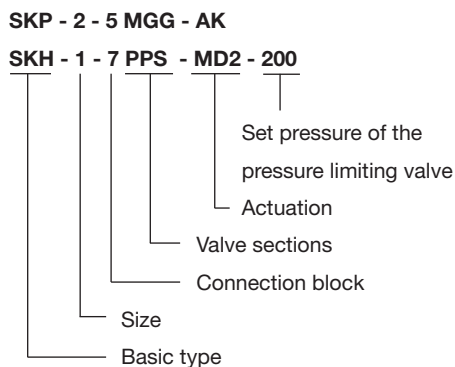

Starting spool valve / adaptor plates / connection blocks

Basic type		Brief description	Symbol	
Connected in parallel	in series		SKP--6..	SKH--6..
SKP--. - 6..	SKH--. - 6..	Starting spool valve block with manually or tool adjustable pressure limiting valve		

Additional versions of starting spool valves, adaptor plates and connection blocks

- Starting spool valve without pressure limiting valve
- Adaptor plates for direct mounting onto connection blocks of hydraulic power packs type R and Z
- Connection blocks with or without pressure limiting valve for pipe connection
- Adaptor plates for direct mounting onto hydraulic power packs type HC, MP, and HK (type SKC)

Symbols

max. 8 valve sections (type SKH) or max. 12 valve sections (type SKP) may be combined in a valve bank, depending on size

Basic symbol

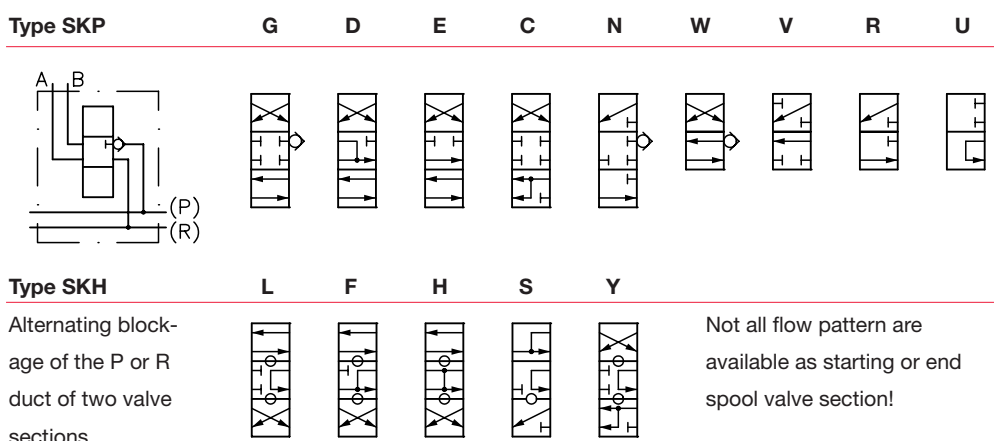

Solenoid voltage

- 12V DC, 24V DC, 230V AC 50/60 Hz
- Other voltage on request
- Plugs with LED, improving EMC or with economy circuit (see also "Additional informations")
- Other actuations analogues to directional spool valves type SG and SP (see also "Additional informations")

Additional versions (symbols)

- Choice of positive (blocked in intermediate positions) and negative (slightly overlapping) over lapping directional spool valves
- Without check valve in P

End spool valve/end plates

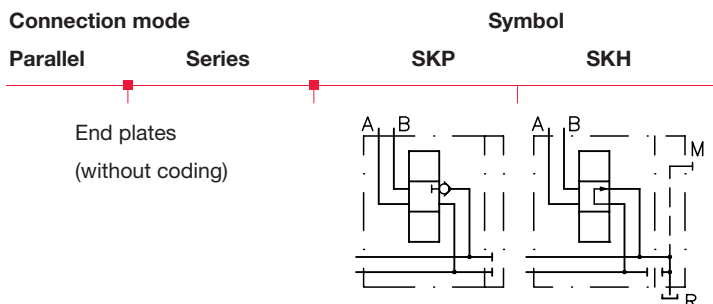

Order examples

SKP-3-5 UGD - ME2/MD2/24

Directional valve bank type SKP connected in parallel, size 3, starting spool valve section without pressure limiting valve (coding 5) with flow pattern U and two add-on spool valves with flow pattern symbols G, D; flow pattern U solenoid actuated (ME2), flow pattern G and D solenoid actuated (MD2), solenoid voltage 24V DC

SKH-2-4 LYSH - AK - 200

Directional valve bank type SKH connected in series, size 2, starting spool valve section with manually adjustable pressure limiting valve (coding 4) and flow pattern L, add-on spool valves with flow pattern symbols Y, S, H; manual actuation with protected housing version type AK and set pressure of the pressure limiting valve 200 bar

Dimensions

Type SKP (see order example)

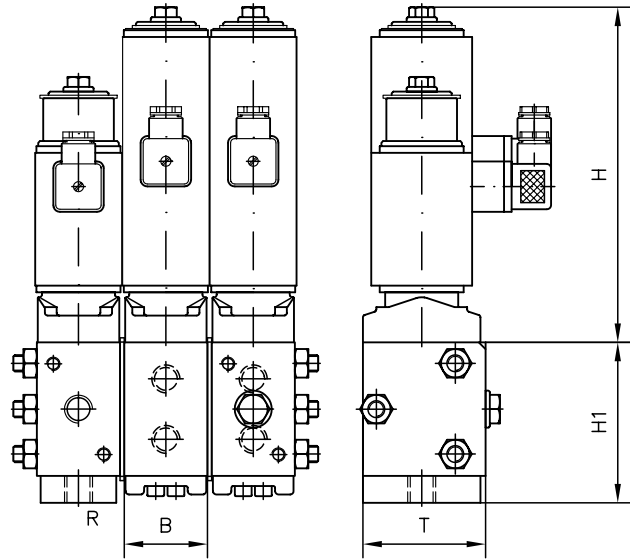

Type SKH (see order example)

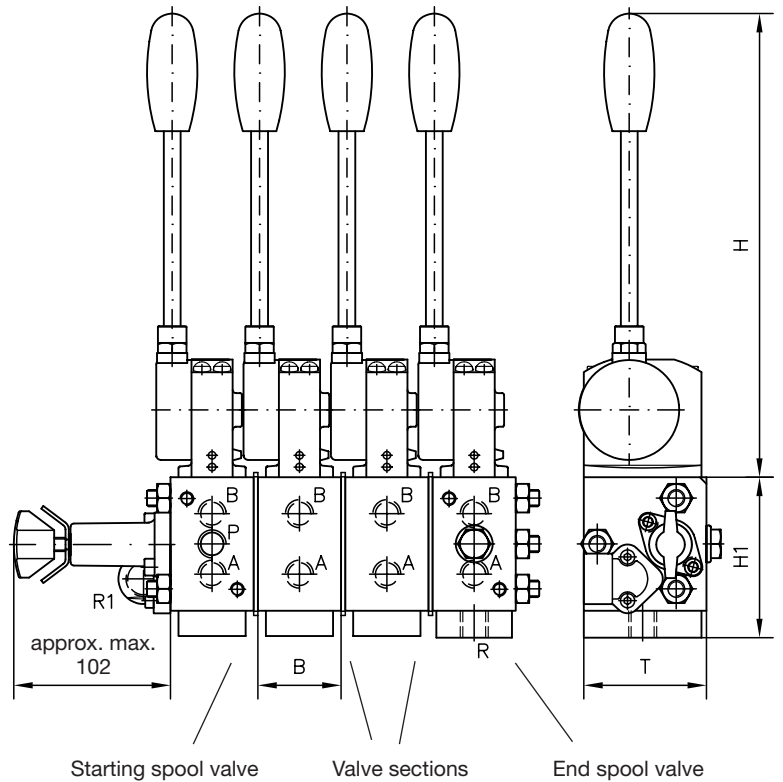

Symbols (see order example)

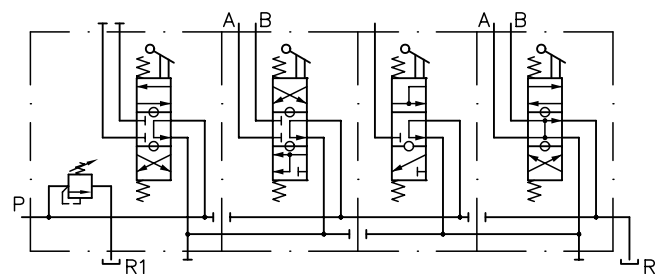
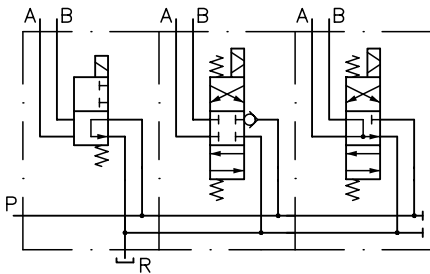

Basic type	H _{max}	H1	T	B	m (kg) ²⁾
SKP 0(1)	151	68.5	51	39.5	1.1 ... 1.8
SKH 0(1)	151	68.5	51	39.5	1.1 ... 1.8
SKP 2(3)	275	49.5 ... 52	73	52	2.7 ... 6.5
SKH 2(3)	275	49.5 ... 52	73	52	2.7 ... 6.5
SKP 4	275	49.5 ... 52	80	52	3.1 ... 6.9
SKH 4	275	49.5 ... 52	80	52	3.1 ... 6.9

All dimensions in mm, subject to change without notice!

²⁾ Per valve section, depending on actuation

Additional information

- Directional spool valve type SKH(P) 0 ... SKH(P) 4 D 7230
type SG, SP D 5650/1
- Plugs with LED etc. D 7163
- Plugs with economy circuit D 7813

- Actuations:
Manual D 6511/1
Solenoid D 7055
Pressure D 6250

• See also "Turn-key solutions out of the modular system"

For page and section of the devices additionally listed, see type index

Example circuit

R23,5/B100 A200 - V9 - SKP28 - U2/G2 E - ME3/24/MD3/24

Hydraulic power pack type R, consisting of:
 Pump R23,5, tank B100, connection block (coding A) with pressure limiting valve (200 bar) and drive motor (P_N = 9 kW, coding V9)

Valve bank connected internally in parallel, 3 valve sections and intermediate plates for solenoids with increased performance MD(E)3 (solenoids are wider than the valve sections)

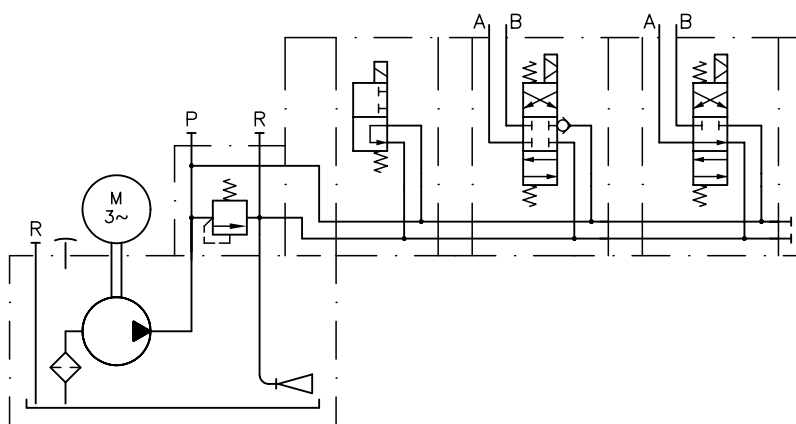

Main parameter of the example circuit

- Q_{pu} = 23.5 lpm (at 1450 rpm)
- p_{max P} = 250 bar
- p_{system} = 200 bar
- V_{consum} = 120 l
- P_{N drive} = 9 kW

