

K

Standard Hydraulic Power Units Power Packages

Energy-Saving Hydraulic Units and Controllers

Energy-Saving Control System for
Hydraulic Units
(Energy-Saving Controller)



Page 811

Equipped with the variable
displacement vane pump
<YM-e Pack>

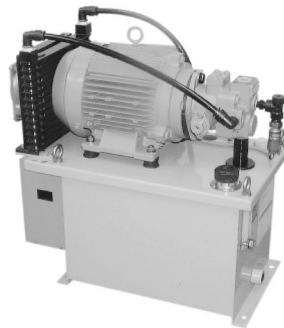

Page 812

Equipped with the variable
displacement piston pump
<YA-e Pack>



Page 813

Standard Hydraulic Power Units

Space-Saving & Low Noise
<YF Pack>

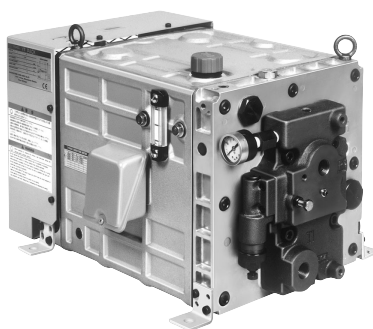

Page 814

Low Noise & Small Type
<YP Pack>

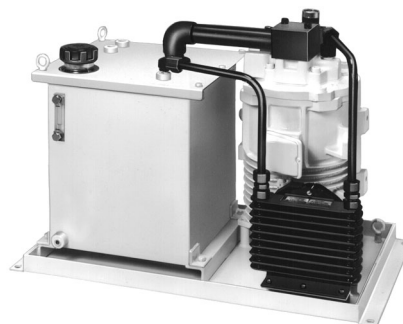

Page 815

AC Servo Motor Driven Hydraulic Pump Control System

Intelligent Hydraulic
Servo Drive Pack

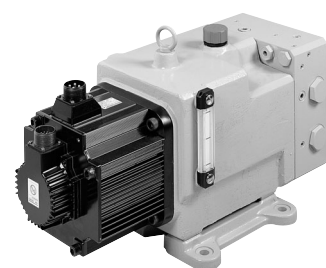

Page 816

Energy-Saving Hydraulic Units and Controllers

Substantial energy saving of hydraulic units has been achieved by the inverter drive.

Hydraulic units equipped with variable displacement pumps feature greater energy-saving than those with fixed displacement pumps. Yuken's energy-saving hydraulic units and controllers utilize rotational frequency control with an inverter. This innovative configuration solves the problem of efficiency losses suffered by induction motors operating at light loads and ensures significant energy savings.



Efficiency Characteristics of Induction Motor

- At Rated Output: Maximum Efficiency
- At Light-load: Significant Efficiency loss

Rotational frequency control is effective for reducing power loss.

Extensive energy saving is possible by detecting a load pressure with the pressure sensor and keeping the motor rotation at the optimum level required for pressure holding. Based on the concept above, the following three different types of inverter-driven system and packages have been developed.

- **Energy-saving control system for hydraulic units (Energy saving controller)**
For modification of existing hydraulic units to energy-saving type
- **Equipped with the variable displacement vane pump <YM-e Pack>**
- **Equipped with the variable displacement piston pump <YA-e Pack>**

● Example of reduction of power consumption with rotational frequency control

Combination of the A37 piston pump and 7.5 kW (10 HP) motor

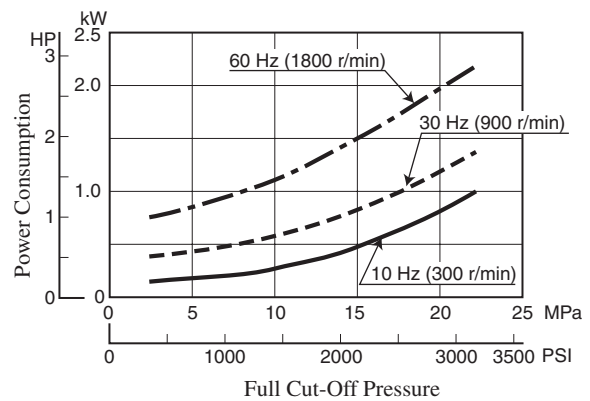

Features of YUKEN energy-saving units / controllers

- **Extremely easy operation and maintenance**
Adjustment and maintenance works are very easy as basically the conventional power unit is used.
- **Significant reduction of power consumption**
With rotational frequency control, more than 40% of power consumption at pressure holding is possible compared to conventional hydraulic units.
- **Low Noise**
Especially the noise level at the full-cutoff is reduced.
- **Discharge volume can be set to a certain volume at 50/60 Hz.**
Regardless the power supply frequency, the rotation speed at the maximum discharge volume can be set by the inverter within the range from 1500 to 1800 r/min.
- **Continuous operation is possible even at breakdown of the pressure sensor or the inverter.**
Operation at a certain rotation speed is possible even without receiving a signal from the pressure sensor due to breaking of wire or malfunction of the pressure sensor. In case of malfunction of the inverter itself, the same operation mentioned above is possible by reconnecting of the primary power supply to the electric motor.

Energy-Saving Control System for Hydraulic Units (Energy-Saving Controller)

Energy-saving effect can be obtained by adding the controller, the pressure sensor, and the inverter to an existing unit and carrying out simple adjustment.



System Configuration

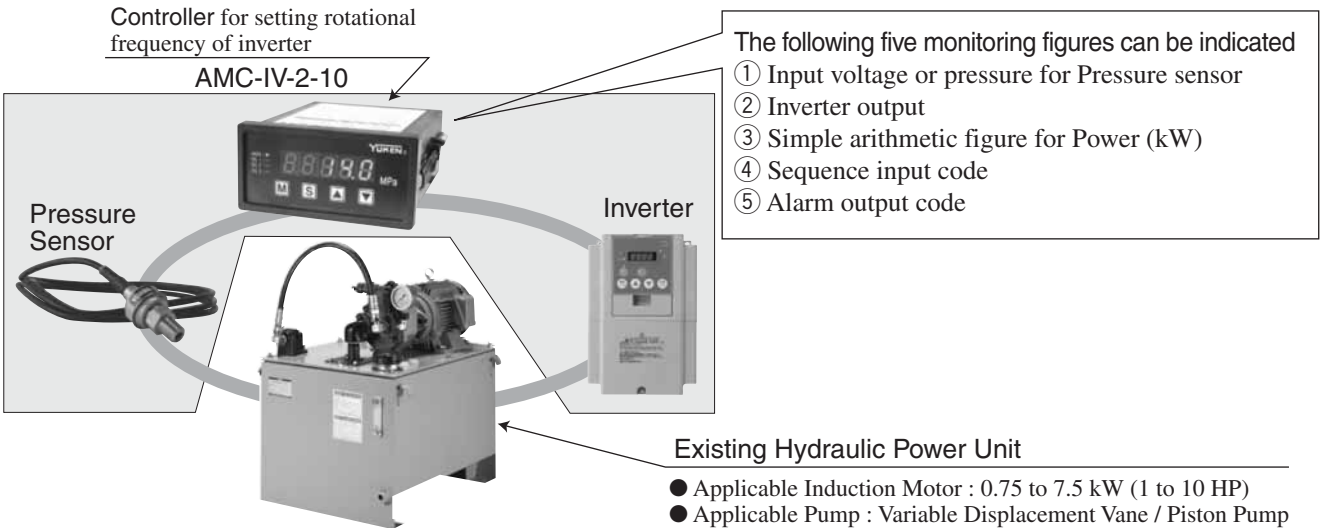

Specifications

| Model | Output Voltage for Inverter | Input Voltage for Pressure Sensor | Power Supply for Pressure Sensor | Voltage for Power Source | Power Consumption | Ambient Temperature |
|-------------|--|-----------------------------------|----------------------------------|--------------------------|-------------------------|---------------------|
| AMC-IV-2-10 | Select one of the following voltage (0 to +5 V, +1 to +5 V, +0.5 to 4.5 V) | +5 V | AC 100/200 V | Less than 6 VA | 0 to 50°C (32 to 112°F) | |

Example of Reduction Rate of Power Consumption (Machining line for auto parts)

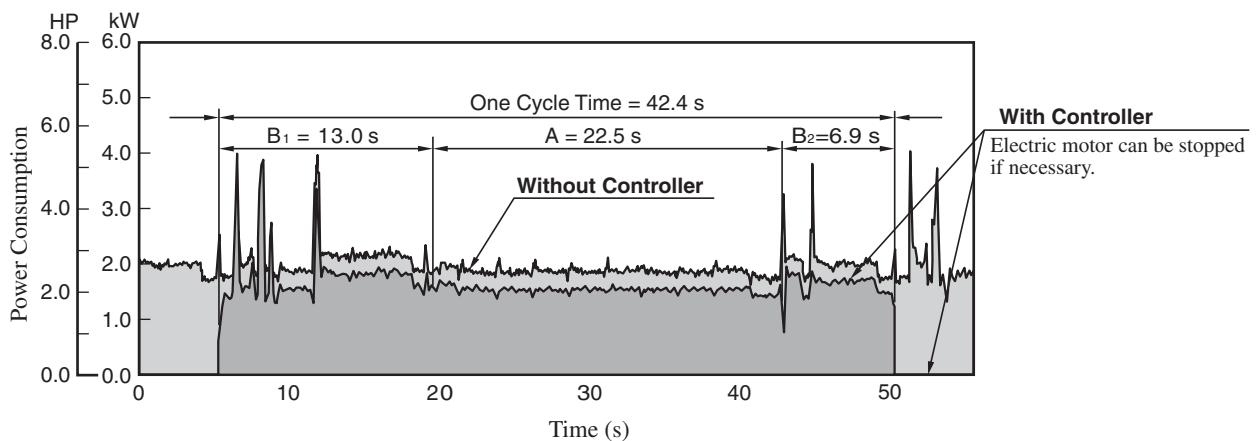

| Symbol | Status | Average of Power Consumption | | |
|---------------------------------|-------------|------------------------------|-------------------|----------------|
| | | Without Controller | With Controller | Reduction Rate |
| A | Standby | 1.80 kW (2.41 HP) | 1.47 kW (1.97 HP) | Approx. 18% |
| B ₁ + B ₂ | Actual Work | 2.01 kW (2.70 HP) | 1.69 kW (2.27 HP) | Approx. 16% |

Consult Yuken when detailed material such as dimensions figures is required.

Energy-Saving Hydraulic Units – Equipped with Vane Pump <YM-e Pack>

Energy-saving unit equipped with the high performance variable displacement vane pump.

Specifications

| Model Numbers | Max. Operating Pressure MPa (PSI) | Setting Range of Rotation Speed at Max. Discharge r/min | Mass (Does not include hydraulic fluid) kg (lbs.) |
|-----------------|--------------------------------------|--|--|
| E-YM8-A-2-*-30 | 3.5 (510) | 1500 – 1800 | 0.75 kW: 43 (94.8) 1.5 kW: 49 (108) 2.2 kW: 56 (123) |
| E-YM8-B-2-*-30 | 7.0 (1020) | | |
| E-YM16-A-2-*-30 | 3.5 (510) | | |
| E-YM16-A-2-*-30 | 7.0 (1020) | | |



Model Number Designation

| E-YM | 8 | -A | -2 | -0.75 | -30 |
|--|--|--|-----------------------|---|---------------|
| Series Number | Geometric Displacement | Pressure Adj. Range | Reservoir Capacity | Electric Motor | Design Number |
| E-YM: Compact Energy-Saving Hydraulic Unit YM-e Pack | 8: 8.6 cm ³ /rev (.525 cu.in./rev) | A: 1.75–3.5 MPa (255–510 PSI) B: 3.5–7.0 MPa (510–1020 PSI) | 2: 20 L (5.3 Gal.) | 0.75: 0.75 kW (1 HP) × 4P 1.5: 1.5 kW (2 HP) × 4P | 30 |
| | 16: 15.6 cm ³ /rev (.952 cu.in./rev) | A: 1.75–3.5 MPa (255–510 PSI) B: 3.5–7.0 MPa (510–1020 PSI) | 2: 20 L (5.3 Gal.) | 0.75: 0.75 kW (1 HP) × 4P 1.5: 1.5 kW (2 HP) × 4P 2.2: 2.2 kW (3 HP) × 4P | |

Power Consumption at Full Cut-Off Pressure

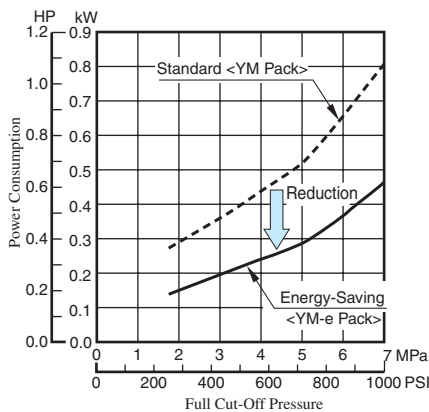

Example of Power Consumption of Grinding Machine

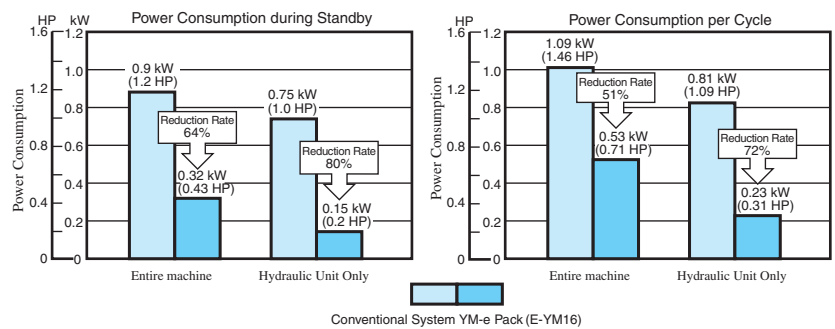

Noise Characteristics (Example) [Measurement Point: 1 m (3.3 ft.) horizontally away]

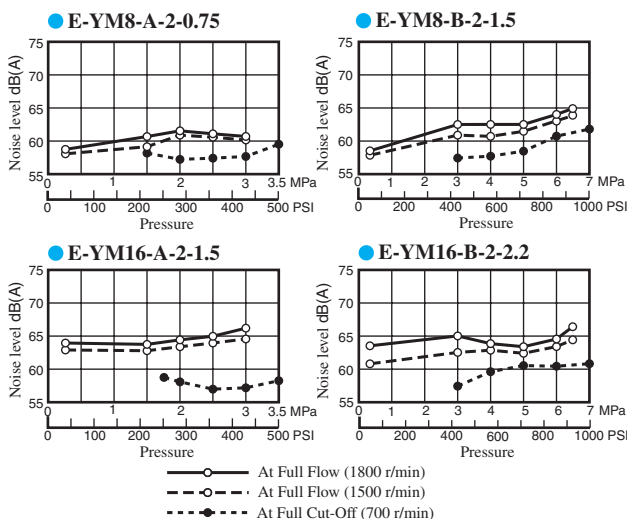

Characteristics of Oil Temperature Increase in the Reservoir (At 700 r/min)

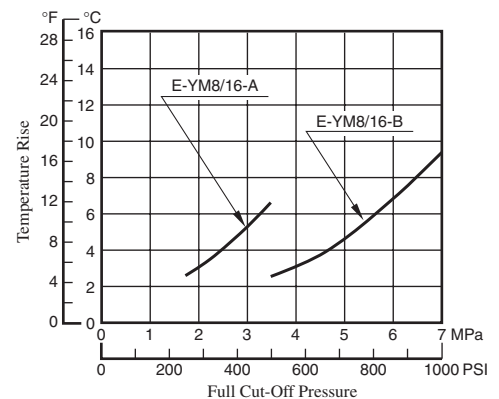

Consult Yuken when detailed material such as dimensions figures is required.

Energy-Saving Hydraulic Units – Equipped with Piston Pump <YA-e Pack>

Energy-saving units equipped with the high efficiency, high performance AR/A series variable displacement piston pumps.

Specifications

| Model Numbers | Max. Operating Pressure MPa (PSI) | Reservoir Capacity L (Gal.) | Setting Range of Rotation Speed at Max. Discharge r/min |
|--------------------|--------------------------------------|--------------------------------|---|
| E-YA10-B-6-41 | 7 (1020) | 60 (15.9) | 1500 – 1800 |
| E-YA10-C-6-41 | 16 (2320) | | |
| E-YA10-C-10-41 | 16 (2320) | 100 (26.4) | |
| E-YA16-B-6-41 | 7 (1020) | 60 (15.9) | |
| E-YA16-B-10-41 | 7 (1020) | 100 (26.4) | |
| E-YA16-C-6-41 | 16 (2320) | 60 (15.9) | |
| E-YA16-C-10-41 | 16 (2320) | 100 (26.4) | |
| E-YA22-B-6-41 | 7 (1020) | 60 (15.9) | |
| E-YA22-B-10-41 | 7 (1020) | 100 (26.4) | |
| E-YA22-C-10-41 | 16 (2320) | | |
| E-YA37-B-10-3.7-41 | 7 (1020) | 100 (26.4) | |
| E-YA37-B-16-41 | 7 (1020) | 160 (26.4) | |



Model Number Designation

| E-YA | 10 | -B | -6 | -2.2 | -41 |
|--|---|---------------------------------|--|---|---------------|
| Series Number | Geometric Displacement | Pressure Adj. Range | Reservoir Capacity | Electric Motor | Design Number |
| E-YA: Energy-Saving Hydraulic Unit YA-e Pack | 10: 10.0 cm ³ /rev (.610 cu.in./rev) | B: 1.2–7 MPa (170–1020 PSI) | 6: 60 L (15.9 Gal.) | 2.2: 2.2kW (3 HP) × 4P | 41 |
| | | C: 2.0–16 MPa (290–2320 PSI) | 10: 100 L (26.4 Gal.) | 2.2: 2.2kW (3 HP) × 4P 3.7: 3.7kW (5 HP) × 4P | |
| | 16: 15.8 cm ³ /rev (.964 cu.in./rev) | B: 1.2–7 MPa (170–1020 PSI) | 6: 60 L (15.9 Gal.) | 2.2: 2.2kW (3 HP) × 4P 3.7: 3.7kW (5 HP) × 4P | |
| | | C: 2.0–16 MPa (290–2320 PSI) | 10: 100 L (26.4 Gal.) | 2.2: 2.2kW (3 HP) × 4P 3.7: 3.7kW (5 HP) × 4P 5.5: 5.5kW (7.4 HP) × 4P 7.5: 7.5kW (10 HP) × 4P | |
| | 22: 22.2 cm ³ /rev (1.355 cu.in./rev) | B: 1.2–7 MPa (170–1020 PSI) | 6: 60 L (15.9 Gal.) 10: 100 L (26.4 Gal.) | 2.2: 2.2kW (3 HP) × 4P 3.7: 3.7kW (5 HP) × 4P | |
| | | C: 2.0–16 MPa (290–2320 PSI) | 10: 100 L (26.4 Gal.) | 5.5: 5.5kW (7.4 HP) × 4P 7.5: 7.5kW (10 HP) × 4P | |
| | 37: 36.9 cm ³ /rev (2.25 cu.in./rev) | B: 1.2–7 MPa (170–1020 PSI) | 10: 100 L (26.4 Gal.) | 3.7: 3.7kW (5 HP) × 4P | |
| | | C: 2.0–16 MPa (290–2320 PSI) | 16: 160 L (42.3 Gal.) | 5.5: 5.5kW (7.4 HP) × 4P 7.5: 7.5kW (10 HP) × 4P | |

Power Consumption at Full Cut-Off Pressure

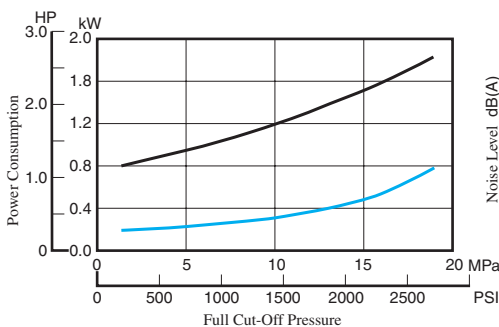

Noise Characteristics

[Full Cut-Off, 1 m (3.3 ft.) horizontally away]

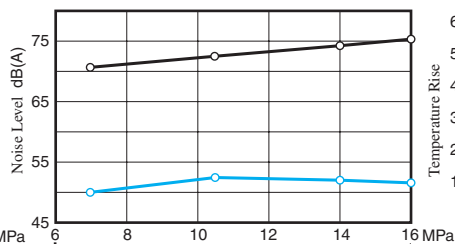

Characteristics of Oil Temperature Increase in the Reservoir

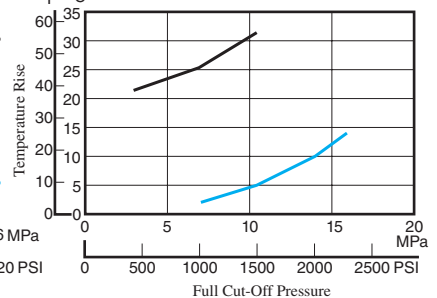

—○— : Standard Type <YA37, 3.7kW, 1800 r/min>
—○— : Energy-Saving Type <E-YA37, 3.7kW, 300 r/min>

Consult Yuken when detailed material such as dimensions figures is required.

Space-Saving & Low Noise Type Hydraulic Power Units <YF Pack>

The Keywords are Cubic Structure

YF PACK are cubic integrated construction of Piston Pump, Electric Motor and Reservoir etc. Each function module linked directly together has allowed us to realize our pipeless concept which means no oil leakage.

Energy-Saving & Low Oil Temperature Rise

YF PACK save 10% of their energy consumption compared to YP pack. Improving cooling capacity reduced thermal radiation. Machines, in which YF PACK can be built, are free from heat distortion.

Temperature Rise

- Model Number: YF16-B-1-2.2-H-20
- Frequency: 50 Hz
- Pressure: Full-cut off at 7 MPa (1020 PSI), Continuous

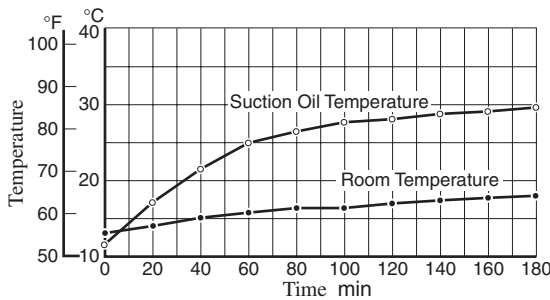

Noise Level 53 dB (A) & Low Vibration

We made the best of our hydraulic technology to take low noise and vibration. YUKEN has achieved noise level 53 dB (A).

Noise Level

- Model Number: YF16 - C - 1 - 1.5 - H - 20
- One metre (3.3 ft.) horizontally away from YF Pack (average of five directions)
- Viscosity: 32 mm²/s (150 SSU) [ISO VG 32 Oils, 40 °C (104 °F)]
- Frequency: 50 Hz (1500 r/min)

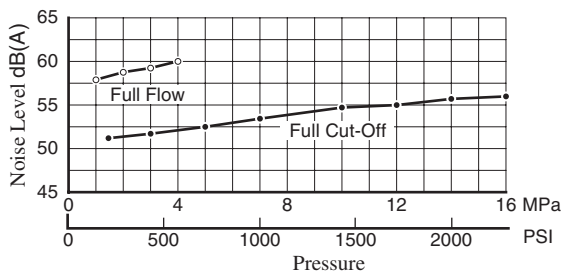

Specifications

| Model Numbers | Geometric Displacement cm ³ /rev (cu.in. ³ /rev) | Pressure Adjustment Range MPa (PSI) | Reservoir Capacity L (Gal.) | Electric Motor (4 Poles), 200 V AC (50 Hz) 200/220 V AC (60 Hz) | Approx. Mass kg (lbs.) | |
|------------------------|---|--|--------------------------------|---|---------------------------|----------|
| YF10-B-1-0.75-H-**-20* | 10.0 (.610) | 1.2- 7 (170-1020) | 10 (2.6) | 0.75 kW (1 HP) | 44 (97) | |
| YF10-B-1-1.5-H-**-20* | | 1.2- 7 (170-1020) | | 1.5 kW (2 HP) | 49 (108) | |
| YF10-C-1-1.5-H-**-20* | | 2.0-16 (290-2320) | | 1.5 kW (2 HP) | 49 (108) | |
| YF16-B-1-1.5-H-**-20* | 15.8 (.964) | 1.2- 7 (170-1020) | 10 (2.6) | 1.5 kW (2 HP) | 49 (108) | |
| YF16-B-1-2.2-H-**-20* | | | | 2.2 kW (3 HP) | 51 (112) | |
| YF16-B-2U-2.2-H-**-20* | | | | 20 (5.3) | 2.2 kW (3 HP) | 57 (126) |
| YF16-B-2S-2.2-H-**-20* | | | | | 2.2 kW (3 HP) | 57 (126) |
| YF16-C-1-1.5-H-**-20* | | | | | 1.5 kW (2 HP) | 49 (108) |
| YF16-C-1-2.2-H-**-20* | 15.8 (.964) | 1.2-16 (170-2320) | 10 (2.6) | 2.2 kW (3 HP) | 51 (112) | |
| YF16-C-2U-2.2-H-**-20* | | | | 20 (5.3) | 2.2 kW (3 HP) | 57 (126) |
| YF16-C-2S-2.2-H-**-20* | | | | | 2.2 kW (3 HP) | 57 (126) |

Consult Yuken when detailed material such as dimensions figures is required.

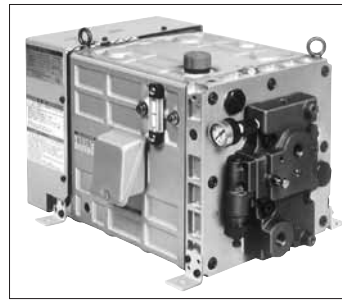

Graphic Symbol

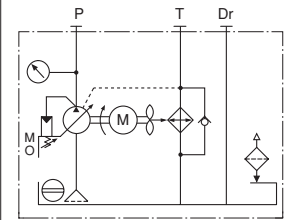

Options

You may have 10 options choosing various accessories: -size 005/01 base blocks (one station – three stations), thermo-sensor, pressure switch etc.

Set up Space Halved (compared to YP pack)

Smaller size and lighter weight of our unique cubic structure make YF PACK easy to build in various machines.

- Volume Reduced 50 % (Compared to YP Pack)
- Mass Reduced 30 % (Compared to YP Pack)

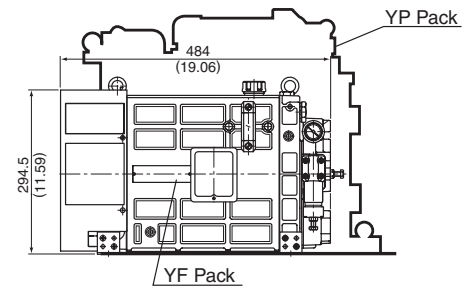

Model Number Designation

YF10 - B - 1 - 1.5 - H - * - * - * - 20 *

- | | | | | | | | | |
|--------------------------|-----------------------------|----------------------|------------------|-----------------------------------|------------------------------|-----------|--------------------|--|
| ① | ② | ③ | ④ | ⑤ | ⑥ | ⑦ | ⑧ | |
| ① Geometric Displacement | ② Pressure Adjustment Range | ③ Reservoir Capacity | ④ Electric Motor | ⑤ Base Block Size.....5:005, 1:01 | ⑥ No. of Base Block Stations | ⑦ Options | ⑧ Design Standards | |
| | | | | } Refer to Specifications | | | | |
| | | | | } None: Without Base Block | | | | |
| | | | | } Omit if not Required | | | | |
- ⑥ 1: 1 Station, 2: 2 Stations, 3: 3 Stations
- ⑦ M: Magnet Filter, L: Level Sensor
P: Pressure Sensor, T: Thermo Sensor
- ⑧ None: Japanese Standard "JIS"
950: N. American Design Standard

Low Noise & Small Type Hydraulic Power Unit <YP Pack>

Quiet-Low Vibration

Equipped with low-noise PAL pump and drain cooler. Also, low noise and vibration levels have been achieved by effectively arraying the components to control vibration.

Noise Level

- Model Number: YP16-C-2-2.2-22
- One metre (3.3 ft.) horizontally away from YP Pack

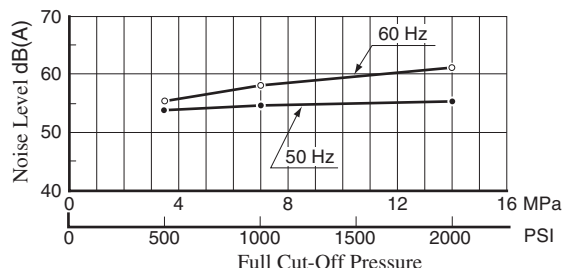

Graphic Symbol

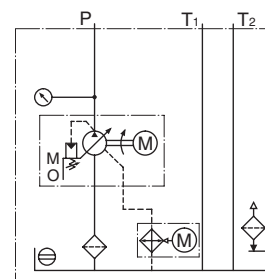

Compact

YP pack is well designed to be compact by uprighting the PAL pump and reducing the reservoir size with added drain cooler. It saves floor space for installation.

Low Fluid Temperature Rise

Standard equipment, built-in drain cooler and radiator fins, reduce the fluid temperature rise ratio. Good solution for heat distortion.

Temperature Rise

- Model Number: YP16-B-1-2.2-20
- Frequency: 50 Hz
- Pressure: Full-cut off at 7 MPa (1020 PSI), Continuous

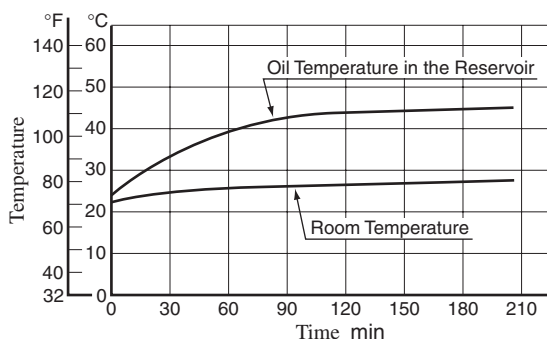

Model Number Designation

YP10 - B - 1 - 1.5 - 22

① ② ③ ④

- ① Geometric Displacement (Refer to Specifications)
- ② Pressure Adjustment Range
 B: 1.2 – 7 MPa (170 – 1020 PSI)
 C: 1.2 – 16 MPa (170 – 2320 PSI)
 [YP10 Only
 C: 2.0 – 16 MPa (290 – 2320 PSI)]
- ③ Reservoir Capacity (Refer to Specifications)
- ④ Electric Motor (Refer to Specifications)

Line Up

YP packs offer nine different models in variety. Eight kinds of optional YP pack are available such as YP pack with control circuit consists of modular & solenoid operated directional valve.

Specifications

| Model Numbers | Geometric Displacement cm ³ /rev (cu.in. ³ /rev) | Pressure Adjustment Range MPa (PSI) | Reservoir Capacity L (Gal.) | Electric Motor (4 Poles), 200 V AC (50 Hz) 200/220 V AC (60 Hz) | Approx. Mass kg (lbs.) |
|------------------|---|--|--------------------------------|---|---------------------------|
| YP10-B-1-0.75-22 | 10.0 (.610) | Refer to Model Number Designation | 10 (2.6) | 0.75 kW (1 HP) | 58 (128) |
| YP10-*1-1.5-22 | | | | 1.5 kW (2 HP) | 68 (150) |
| YP16-*1-1.5-22 | 15.8 (.964) | Refer to Model Number Designation | 10 (2.6) | 1.5 kW (2 HP) | 68 (150) |
| YP16-*1-2.2-22 | | | | 2.2 kW (3 HP) | 78 (172) |
| YP16-*2-2.2-22 | | | | 20 (5.3) | 2.2 kW (3 HP) |
| YP22-*2-2.2-22 | 22.2 (1.355) | Refer to Model Number Designation | 20 (5.3) | 2.2 kW (3 HP) | 78 (172) |
| YP22-*3-3.7-22 | | | 30 (7.9) | 3.7 kW (5 HP) | 105 (234) |
| YP37-*3-3.7-22 | 36.9 (2.25) | Refer to Model Number Designation | 30 (7.9) | 3.7 kW (5 HP) | 145 (320) |
| YP37-*3-5.5-22 | | | | 5.5 kW (7.4 HP) | 145 (320) |

Consult Yuken when detailed material such as dimensions figures is required.

AC Servo Motor Driven Hydraulic Pump Control System

Intelligent Hydraulic Servo Drive Pack

The IH (intelligent hydraulic) servo drive pack is a compact energy-saving and low-noise hydraulic device which is combined as one with the AC servo motor, piston pump, reservoir and hydraulic control circuit. This combination can control the number of revolutions of the servo motor and adjust the discharge and pressure of the pump. This device can be combined with the sensor – equipped cylinder and dedicated controller to facilitate the configuration of a position, speed and pressure control system.

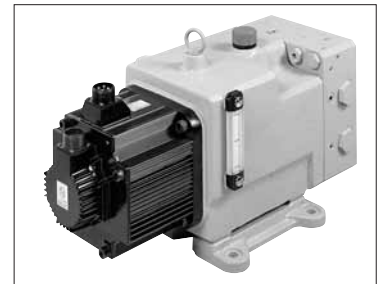

Energy Saving

The operation at the number of revolutions meeting the machine requirements (flow rate and pressure) reduces useless power losses and provides energy savings.

Low Noise

During pressure control, the pump rotation compensating for the internal leakage of oil pressure provides low revolutions with almost no noise.

During flow control, the number of revolutions meeting the machine requirements ensures lower noise generation than conventional devices.

Compactness

A substantial reduction in heat generation enables the operation with a minimum amount of fluid oil for cylinder operation in addition something extra oil. This results in a combination of the servo motor, piston pump, reservoir and hydraulic control circuit in one, providing energy savings.

Incorporation into an integral part of the machine is also possible.

Digital Control

Software control of the dedicated controller allows a system to have a great deal of versatility because of making use of a CPU. Digital control parameter setting facilitates to operate the system and its maintenance, furthermore the analog input/output ports provide as standard for user interface.

Specifications

| Model Numbers | Geometric Displacement of Pump cm ³ /rev (cu. in./rev) | Maximum Shaft Speed r/min | Thrust Output and Cylinder bore | Reservoir Capacity cm ³ (cu. in.) | Oil Level Variations cm ³ (cu. in.) |
|-------------------------------------|--|---|---|---|---|
| YSD1-∗-09 YSD1-∗-13 | 6 (.366) 10 (.610) | 2000 Note) It may vary according to AC servo motor output and operating pressure. | 20 – 30 kN (45 – 67.4 lbs.) Cyl. Bore 63 mm (2.48 in.) | 2500 (152.6) | 1500 (91.5) |
| YSD2-∗-18 YSD2-∗-29 YSD2-∗-44 | 6 (.366) 10 (.610) 16 (.976) | | 50 – 60 kN (112 – 135 lbs.) Cyl. Bore 80 mm (3.15 in.) | 4200 (256.3) | 2500 (152.6) |
| YSD3-∗-55 YSD3-∗-75 | 10 (.610) 16 (.976) 30 (1.831) | | 100 kN (225 lbs.) Cyl. Bore 100 mm (3.94 in.) | 5800 (353.9) | 3500 (213.6) |

AC Servo Motor Output and Operating Pressure (for reference)

Continuous Operating
 Short Time Operating

| Model Numbers | AC Servo Motor | | Geometric Displacement cm ³ /rev (cu. in./rev) | Max. Operating Pres. MPa (PSI) | | | | | |
|---------------|-------------------|-------------------------------|---|-----------------------------------|---------------|----------------|----------------|----------------|----------------|
| | Output kW (HP) | Rated Torque Nm (in. lbs.) | | 3.5 (510) | 7.0 (1020) | 10.5 (1525) | 14.0 (2030) | 17.5 (2540) | 21.0 (3.50) |
| YSD1-∗-09 | 0.85 (1.14) | 5.39 (44.7) | 6 (.366) | | | | | | |
| | | | 10 (.610) | | | | | | |
| YSD1-∗-13 | 1.3 (1.74) | 8.34 (73.8) | 6 (.366) | | | | | | |
| | | | 10 (.610) | | | | | | |
| YSD2-∗-18 | 1.8 (2.4) | 11.5 (101.8) | 6 (.366) | | | | | | |
| | | | 10 (.610) | | | | | | |
| | | | 16 (.976) | | | | | | |
| YSD2-∗-29 | 2.9 (3.9) | 18.6 (165) | 10 (.610) | | | | | | |
| | | | 16 (.976) | | | | | | |
| YSD2-∗-44 | 4.4 (5.9) | 28.4 (251) | 10 (.610) | | | | | | |
| | | | 16 (.976) | | | | | | |
| YSD3-∗-55 | 5.5 (7.4) | 35 (310) | 16 (.976) | | | | | | |
| | | | 30 (1.831) | | | | | | |
| YSD3-∗-75 | 7.5 (10.1) | 48 (425) | 16 (.976) | | | | | | |
| | | | 30 (1.831) | | | | | | |

Note: The above table is guidance for model selection. It is required to take operating condition of hydraulic power unit such as cycle time in consideration when selecting the AC servo motor. Please contact us for more details.

Model Number Designation

| YSD3 | - F | - 55 | A | 55 | - 16 | - H | R | - B | A | B | R | - 20 | * |
|------------|--|--|---|--|---|---|--|---|---|---|--|---------------|-------------|
| Series No. | Mtg. Type | Servo Motor Output | Direction of Servo Motor Connection | Servo Pack | Geometric Displacement of Pump cm ³ /rev (cu. in./rev) | Relief Valve Setting Pres. MPa (PSI) | Location of Pressure Sensor | Location of Counter-balance Valve | Setting Pres. of Head Side Counter-balance Valve MPa (PSI) | Setting Pres. of Rod Side Counter-balance Valve MPa (PSI) | Location of Shut-off Valve | Design Number | Design Std. |
| YSD1 | | N1: Without Servo Motor (for 0.85 kW) N2: Without Servo Motor (for 1.3 kW) 09: 0.85 kW (1.14 HP) 13: 1.3 kW (1.74 HP) | (Viewed from the Motor End) | N: Without Servo Pack 09: 0.85 kW (1.14 HP) 13: 1.3 kW (1.74 HP) | 6: 6 (.366) 10: 10 (.610) | B: 9.5 (1380) C: 18.5 (2680) | H: Head Side | — | — | — | — | 10 | |
| YSD2 | F: Flange Mtg. B: Foot Mtg. | N: Without Servo Motor 18: 1.8 kW (2.4 HP) 29: 2.9 kW (3.9 HP) 44: 4.4 kW (5.9 HP) | A: Upwards B: Downwards R: Right L: Left None: Without Servo Motor | N: Without Servo Pack 18: 1.8 kW (2.4 HP) 29: 2.9 kW (3.9 HP) 44: 4.4 kW (5.9 HP) | 6: 6 (.366) 10: 10 (.610) 16: 16 (.976) | B: 9.5 (1380) C: 18.5 (2680) | R: Rod Side B: Both Sides None: Without pressure Sensor | H: Head Side R: Rod Side B: Both Sides None: Without Counter-balance Valve | B: * - 7 (* - 1020) None: Without Head Side Counter-balance Valve A: 1.8 - 3.5 (260 - 510) B: 3.5 - 7 (510 - 1020) None: Without Head Side Counter-balance Valve | B: * - 7 (* - 1020) None: Without Rod Side Counter-balance Valve A: 1.8 - 3.5 (260 - 510) B: 3.5 - 7 (510 - 1020) None: Without Rod Side Counter-balance Valve | H: Head Side R: Rod Side B: Both Sides None: Without Shut-off Valve | 20 | Refer to ★ |
| YSD3 | | N: Without Servo Motor 55: 5.5 kW (7.4 HP) 75: 7.5 kW (10.1 HP) | None: Without Servo Motor | N: Without Servo Pack 55: 5.5 kW (7.4 HP) 75: 7.5 kW (10.1 HP) | 10: 10 (.610) 16: 16 (.976) 30: 30 (1.831) | H: 23.5 (3410) | H: Head Side | B: Both Sides None: Without Counter-balance Valve | N: * - 1.8 (* - 260) A: 1.8 - 3.5 (260 - 510) B: 3.5 - 7 (510 - 1020) None: Without Head Side Counter-balance Valve | N: * - 1.8 (* - 260) A: 1.8 - 3.5 (260 - 510) B: 3.5 - 7 (510 - 1020) None: Without Rod Side Counter-balance Valve | B: Both Sides None: Without Shut-off Valve | 20 | |

★. Design Standards: None Japanese Standard "JIS"
80 European Design Standard
950 N. American Design Standard

Structure

The IH Servo Drive Pack pump is a bidirectional revolution piston pump which offers high performance in a wide range of very low to high revolutions. The hydraulic control circuit simply consists of safety valves and self priming valve, without a control valve in the pump discharge line and the series line between cylinders. The reservoir is made compact by using space around the pump. With the oil supply port of hydraulic fluid doubling as an air breather and the side-mounted oil level gauge, the pump is well equipped as a hydraulic driving force.

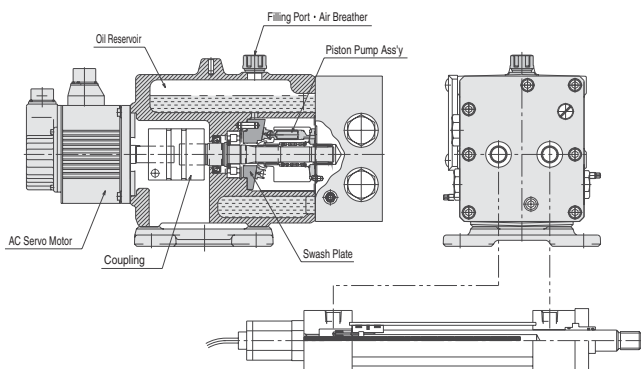

Consult Yuken when detailed material such as dimensions figures is required.

System Configuration

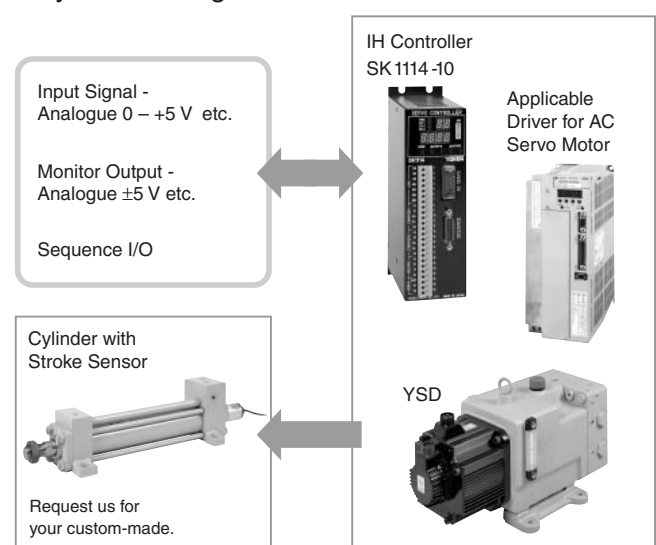

K

Intelligent Hydraulic Servo Drive Pack